

Article number: 20990ALD502000EL

Description: E+G GN 990 Construction tube round
GN 990-AL-D50-2000-EL

Measures

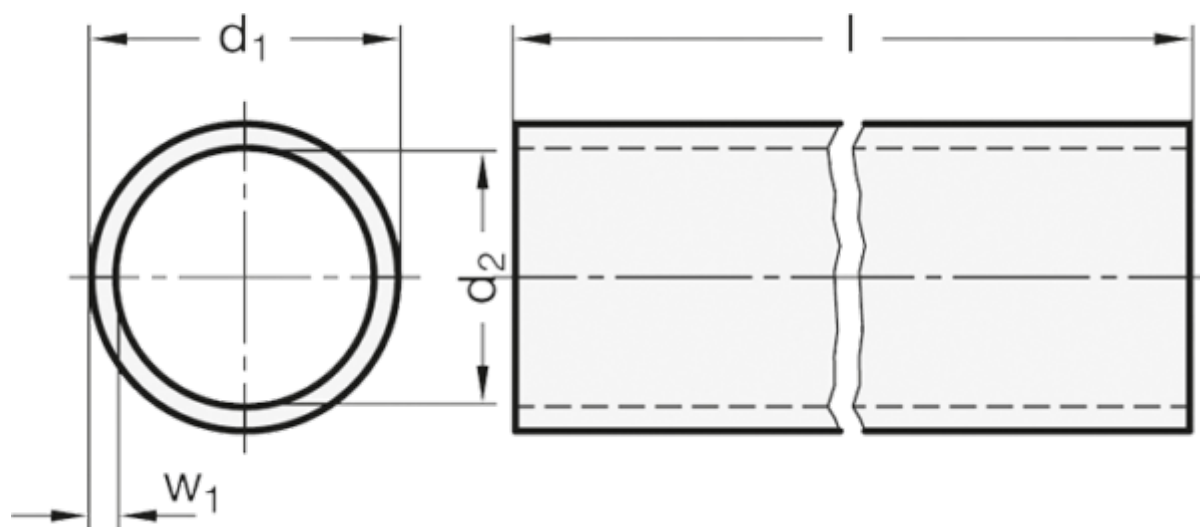

d_1 = D50 \pm 0.2

d_2 = 44

$l \pm 0.5$ = 2000

w_1 = 3

Weight in (g) = 1886